



国际性水处理控制阀专业制造商
International Professional Manufacturer of Control Valve for Water Treatment Systems

中国 · 润新阀

CHINA RUNXIN VALVE



PRODUCT MANUAL ■ 2020-4

目录

CONTENTS



●企业简介Company Profile.....	01-02
●结构与专利Explain Configuration And Patent.....	03-04
●产品选型指南Product Selection Guide.....	06
●手动过滤阀Manual Filter Valve.....	07-10
●手动软化阀Manual Softener Valve.....	11-13
●自动过滤阀(LED显示)Automatic Filter Valve (LED Display).....	14-18
●自动软化阀(LED显示)Automatic Softener Valve (LED Display).....	19-26
●连续供水用多功能控制阀 One Valve On Duplex Tanks for Water Treatment Systems.....	27-28
●一用一备软水系统 One In Service One Standby Softening System.....	29-31
●两用一备连续供水多功能控制阀 Two in service one standby continuously water supplying control valve.....	32-33
●P系列控制阀 P Series Control Valve.....	34-36
●Q系列控制阀 Q Series Control Valve.....	37-38
家用系列控制阀(LCD)Residential Softener of D Series (LCD Display)....	39-42
●浮动床用控制阀 Control Valve for Floating Bed Water Treatment Systems.....	43-45
●旁通阀系列 Bypass Valve Series.....	46-47
●特殊控制阀系列Special Control Valve Series.....	48-52
●其他阀门及配件Other Accessories.....	53



企业简介

COMPANY PROFILE

温州市润新机械制造有限公司成立于2000年，是国家高新技术企业、国家知识产权优势企业、浙江省专利示范企业、温州市领军企业、温州市百佳工业企业、温州市百佳诚信企业，参与了多个国家标准、行业标准的制订。

公司旗下拥有“润新”、“润莱”两个品牌，专业生产水处理系统用多功能控制阀（“润新阀”）、陶瓷芯球阀、润莱民用（商用）水处理器、太阳能热水器控制阀等环保、节能、健康类产品。

其中，公司自主研发、拥有完全自主知识产权的“润新阀”系列产品被评为浙江省名牌产品。因为稳定的性能和优越的适应性优势，“润新阀”被广泛应用于国内外过滤、软化、离子交换系统、锅炉软水系统、泳池过滤和海水淡化系统，并先后获得美国、欧盟、俄罗斯、澳大利亚、韩国等十几个国家发明专利授权，连续九年通过美国NSF认证，产品远销全球120多个国家和地区。

润新公司始终以“谦卑、感恩、诚实、智慧、勤劳”为精神指导，秉承“超越自我、奉献社会”的价值理念，致力于打造“国际性水处理控制阀和民用（商用）水处理器专业制造商”，愿将优质产品和服务带给更多朋友，共享美好生活。

Founded in 2000, Wenzhou Runxin company is the National High-tech Enterprise titled with “National Intellectual Property Advantage Enterprise”, “Patent Demonstration Enterprise”, participated in drafting many national and industry standards.

It has RUNXIN and RUNLUCKY two brands. Its main products include “Runxin Valve”, Runlucky residential water treatment products, ceramic ball valve and valve for solar energy heating, which are eco-friendly, energy-saving, and healthy.

Self-researched and developed with intellectual property right, the core product “Runxin Valve” is authorized as the “Zhejiang Famous Brand Product”. With the advantage of stable performance and excellent adaptation, Runxin Valves are widely utilized in filtration, softening, ion exchange systems, boiler soft water systems, swimming pool filtration and desalination systems. It not only authorized with many patents from 17 countries and regions, like America, EU, Russia, South Korea, Mexico, Australia etc, but also recognized by NSF, CE and RoHS. Runxin Valve has been widely spread in more than 120 countries and regions.

With the spirits of “Humbleness, Gratefulness, Honesty, Wisdom, Diligence” and the value of “Surpass myself, Dedicate to society”, Runxin is devoted to technology innovation and dedicate to become international and professional manufacturer of water treatment control valve and water treatment systems for residential(commercial) applicaton , bring more high quality and service to all over the world, helping more people to achieve better life.



生产能力和规模

一个好的产品，不仅需要合理的管理制度和检测方法，也需要一定规模的生产能力和企业文化作为背景。

Production Capacity and Scale

A good products, not only need the reasonable management institution and test method, it also need a certain scale of production capacity and enterprise culture as background.



F56A全自动装配流水线
F56A fully automatic assembly line



控制阀扭矩定值装配设备
Fixed torque assembly machine for control valve



伺服机械手
Servo manipulator



控制阀气密测试台
Air pressure testing machine for control valve



全自动超声波焊接机
Automatic ultrasonic welding machine



使用十年之润新阀展示区
Display Area of Ten-year Used "Runxin Valve"



花园一角
A corner of the garden



厂区一角
One corner of the factory



游泳池
Swimming Pool



休闲区
Leisure Area

我们拥有自主知识产权

Control device for water treatment systems
with our own independent intellectual property

润新多功能水处理控制阀的结构特点：采用高平面度的陶瓷动片和高强度定片，以及平衡背压，有助于降低机械压力。信号采集设置在一个圆面上，轻松实现全自动控制。

这是一项首创的国际技术，它已经通过了国际专利合作条约。研究报告指出，该技术在工业上具有创造性，新颖性和实用性。在许多国家已经申请并获得了专利，例如美国，日本，欧盟等国家。

Structure characteristic of RUNXIN multi-functional flow control valve for water treatment systems: Adopt high flatness ceramic disk and high strength fixed disk, and balance pressure on back which helps to reduce the mechanical pressure. Signal collection points set on a plan circle easily realize to control automatically.

It is a initial international technology. It has past International Patent Cooperation Treaty Research. The research report is that this product is creative, novel and practical in industry. It has been applied for patent in many countries and gets affiche nos. in America, Japan, EU and other countries.

The principle of hermetic head faces for
RUNXIN automatic control valve

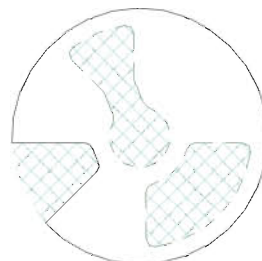

动片
Moving disk

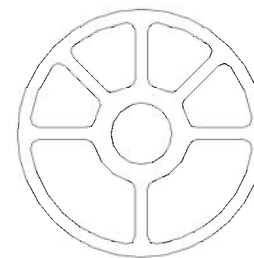

定片
Fixed disk



润新阀的结构，采用固定密封面的旋转实现通道开合以及流向改变。信号采集设置在一个圆面上，轻松实现自动控制，且五个工位不会重复。

RUNXIN valve structure is, for adopting hermetical head faces fixed rotation to realize channel opening and closing, as well as flow direction changing. Signal collection points set on a plan circle easily realize to control automatically and five working positions couldn't be repeated.

国际发明专利 International Invention Patent

- ◎ 国际专利号International Patent Public No.:WO 2006/007772
- ◎ 中国大陆专利号China (Mainland) Patent No.:ZL02220153.X
ZL02257746.7 ZL200420078956.5
- ◎ 美国专利号US Patent No.:US 7,549,446 B2
- ◎ 欧盟专利号EU Patent Application No.:EP05729114.8
- ◎ 俄罗斯专利号Russia Patent No.:2349819
- ◎ 韩国专利号South Korea Patent No.:10-0914137
- ◎ 澳大利亚专利号Australia Patent No.:2005263257
- ◎ 印度专利号India Patent No.:232582
- ◎ 菲律宾专利号Philippines Patent No.:1-2006-502553
- ◎ 墨西哥专利号Mexico Patent No.:268581



美国发明专利
US Patent



欧盟专利
EU Patent



俄罗斯发明专利
Russia Patent



韩国发明专利
South Korea Patent



菲律宾发明专利
Philippines Patent



印度发明专利
India Patent



墨西哥发明专利
Mexico Patent



澳大利亚发明专利
Australia Patent

"润新阀"出口至全球121个国家和地区

Its Products Has Broadly Marketed In 121 Countries And Regions All Over The World



产品选型指南 Product Selection Guide

产水量 Water Treatment Capacity	过滤 Filter		手动软化 Manual softener	自动顺流再生 Automatic/Down-flow		自动逆流再生 Automatic/Up-flow	
	手动 Manual	自动 Automatic	顺逆/流再生 Down-flow/Up-flow	时间型 Time Clock Type	流量型 Meter Type	时间型 Time Clock Type	流量型 Meter Type
1~2 m³/h	51201A/51201B 51201C/51102/51202C	53502/52502H 53502B/64502/55502	61202/61202C 71202(逆流UF)	63502/62502/63502B/64502/65502	63602/62602/63602B/64602/65602	73502/72502/73502B/74502	73602/72602/73602B/74602
	F52/F56B/F56C/F56E/F56EC	F71B1/F71D1 F71G1/F71P/F71Q	F64B/F64BC/F64C(逆流UF)	F65B1/F65D1/F65G1/F65P1/F117Q1	F65B3/F65D3/F65G3/65P3/F117Q3	F69A1/F69D1/F69G1/F69P1	F69A3/F69D3/F69G3/F69P3
3~4 m³/h	51104/51204C	53504S/53504/52504H 53504B/54504/55504/56603	61104/61204C	63504S/63504/62504/63504B/64504/65504	63604S/63604/63604B/64604/65604	73504S/73504/72504/73504B/74504	73604S/73604/72604/73604B/74604
	F58A/F58K/F58AC	F67B/F67C1/F67D1 F67G1/F67P/F67Q/F67N	F64A/F64AC	F63B1/F63C1/F63D1/F63G1/F63P1/F116Q1	F63B3/F63C3/F63G3/F63P3/116Q3	F68A1/F68C1/F68D1/F68G1/F68P1	F68A3/F68C3/F68D3/F68G3/F68P3
5~6 m³/h	51106	53506S	61206	63505E/63505	63605E/63605	72505/73505	72605/73605
	F56F	F67B-A	F64F	F116A1/F130A1	F116A3/F130A3	F92A1-LCD/F92A1-LED	F92A-LCD/F92A-LED
8~10 m³/h	51208/51210	53508/53510/53510B	61210	63508/63510/63510B	63610/63610B		
	F56L/N56D	F134A/N75A1/N75B1	N64D	F133A/N74A1/N74B1	N74A3/N74B3		
12~18 m³/h	51215	53518/53515/53615	61215	63518/63515	63618/63615	73515	73615
	F77BS	N77B1/F99B1/F99B3	F77AS	N77A1/F99A1	N77A3/F99A3	F99D1	F99D3
20 m³/h		53520/53620		63520/63520T	63620/63620T	73520	73620
		F95B1/F95B3		F95A1/F111A1	F95A3/F111A3	F95D1	F95D3
30~40 m³/h	51240	53540B/53640B	61240B	63540B	63640B		
	F112BS	F112B1/F112B3	F112AS	F112A1	F112A3		
50 m³/h		53550/53650		63550	63650		
		F96B1/F96B3		F96A1	F96A3		

其它产品 Others

产品名称 Name	新型号 New Model	原型号 Old Model	备注 Remark	产品名称 Name	新型号 New Model	原型号 Old Model	最大产水量 Water Treatment Capacity	产品名称 Name	新型号 New Model	原型号 Old Model	最大产水量 Water Treatment Capacity
旁通阀 Bypass Valve	41104	F70A	可配F63/F68 Suited with F63/F68	顺逆流软化阀 Down/Up-flow Softener	83602	F79	2 m³/h	混床用控制阀 Control Valve for Mixed Bed	15702	F86	2 m³/h
	41102	F70B	可配F65/F69 Suited with F65/F69		82602	F105	2 m³/h		15704	F87	4 m³/h
	41204	F70C	可配F63/F68/F82 Suited with F63/F68/F82		82603E	F97A3	3 m³/h	除氧用控制阀 Deoxidized Control Valve	13504	F85	4 m³/h
	41202	F70D	专配F79 Suited with F79		83604	F82A3	4 m³/h	连续供水用一阀双罐 One Valve on Duplex Tanks	17603	F73	3.5 m³/h
	41206	F70F	专配F97/F92 Suited with F97/92	93604	F83A3	4 m³/h	17610		F88A	10 m³/h	
	41304	F70G	专配F63/F68/F79/F82/F105控制阀 Suited with F63/F68/F79/F82/F105	93606	F98C	6 m³/h	17606	F98A	6 m³/h		
	41302	F70H	适配F67N/F122控制阀 Suited with F67N/F122	93610	F88C	10 m³/h	电动三通阀 Electronic Three-way Valve	42020	F80	20 m³/h	
	41103	F70I	F70I 适配F79控制阀 Suited with F79	92115	F77CS	15 m³/h	在线取样检测装置 On-line Sampling Monitory Device	44310	F84		
			93620	F95C3	20 m³/h	叠片式过滤器 Disc Filter	45006	F90A	6 m³/h		
			93640	F112C3	40 m³/h		45012	F90B	12 m³/h		
							45020	F90C	20 m³/h		
							45040	F90D	40 m³/h		

说明: 上表中以数字表示的型号为新型号, 以F开头的为原型号。Notice: the digital in above table is new model, and the model begin with "F" is old model.

手动过滤阀 Manual Filter Valve



51204K(F56K)

结构性能特点 Structure Features

- 采用端面密封结构
- 可带压操作，冲洗时无原水旁通
- 手动操作，手柄可旋转180° 安装
- Hermetic head faces structure.
- No hard water bypass and operating can happen on service.
- Manual regeneration. Handel could be rotated and assembled within 180°.

适用场合 Applications

- 家用过滤系统 (F52、F56A、F56B、F56C、F56E、F56F)
- 反渗透预处理的活性炭过滤器、砂过滤器
- 泳池过滤设备 (N56D、F77BS)
- N56D、F77BS通过侧装式连接件倒装可用于除铁除锰等特质水处理系统
- Household Filter System (F52.F56A.F56B.F56C.F56E.F56F).
- A/C filter or sand filter system for RO pretreatment system.
- Swimming Pool Filter System (N56D.F77BS).
- N56D, F77BS can be used for iron/manganese removal system if side mount adapteris installed upside down.

产品型号 Product Model	进水口 Inlet	出水口 Outlet	排水口 Drain	基座 Base	中心管 Riser Pipe	产水量 Water Capacity	适配罐体 Tank Diameter Range for Filters
51204K (F56K)	1"F	1"F	1"F	2.5"-8NPSM	1.05"OD	4 m ³ /h	6"~12"

●F:内牙 M:外牙 OD:外径 ●F:Female M:Male OD:Outer Diameter

专利号 (Patent No.): ZL02257746.7、ZL02220153.X、ZL200720045551.5

手动过滤阀 Manual Filter Valve



产品型号 Product Model	进水口 Inlet	出水口 Outlet	排水口 Drain	基座 Base	中心管 Riser Pipe	产水量 Water Capacity	适配罐体 Tank Diameter Range for Filters
51201A (F52)	1/2"F	1/2"F	1/2"F	M 82×3	Φ 16.5mm	1 m ³ /h	6"~10"
51201B (F56B)	1/2"F or 3/4"F	1/2"F or 3/4"F	1/2"F or 3/4"F	Tr95×6 or φ98 锯齿形 hackle whorl	1.05"OD	1 m ³ /h	10"滤壳 Filter shell
51201C (F56C)	1/2"F or 3/4"F	1/2"F or 3/4"F	1/2"F or 3/4"F	Tr118×6 or Tr110×6	1.05"OD	1 m ³ /h	20"滤壳 Filter shell
51102 (F56E)	1/2"F or 3/4"F	1/2"F or 3/4"F	1/2"F or 3/4"F	2.5"-8NPSM	1.05"OD	2 m ³ /h	6"~10"

●F:内牙 M:外牙 OD:外径 ●F:Female M:Male OD:Outer Diameter

专利号 (Patent No.): ZL02257746.7、ZL02220153.X、ZL200720045551.5

手动过滤阀 Manual Filter Valve



产品型号 Product Model	进水口 Inlet	出水口 Outlet	排水口 Drain	基座 Base	中心管 Riser Pipe	产水量 Water Capacity	适配罐体 Tank Diameter Range for Filters
51202C (F56EC)	1/2"F or 3/4"F	1/2"F or 3/4"F	1/2"F or 3/4"F	2.5"-8NPSM	1.05"OD	2 m ³ /h	6"~10"
51104 (F56A)	1"F	1"F	1"F	2.5"-8NPSM	1.05"OD	4 m ³ /h	6"~12"
51204C (F56AC)	1"F	1"F	1"F	2.5"-8NPSM	1.05"OD	4 m ³ /h	6"~12"
51106 (F56F)	1"F	1"F	1"F	2.5"-8NPSM	1"D-GB	6 m ³ /h	6"~14"

●F:内牙 M:外牙 OD:外径 ●F:Female M:Male OD:Outer Diameter

专利号 (Patent No.):ZL02257746.7、ZL02220153.X、ZL200720045551.5

手动过滤阀 Manual Filter Valve



产品型号 Product Model	进水口 Inlet	出水口 Outlet	排水口 Drain	基座 Base	中心管 Riser Pipe	产水量 Water Capacity	适配罐体 Tank Diameter Range for Filters
51208 (F56L)	1.5"M	1.5"M	1.5"M	4"-8UN	1.25"D-GB 1.66 "OD	8 m ³ /h	16"~24"
51210 (N56D)	2"F	2"F	2"F	4"-8UN	1.5"D-GB 1.9"OD	10 m ³ /h	16"~24"
51215 (N77BS)	2"M	2"M	2"M	4"-8UN	1.5"D-GB 1.9"OD	15 m ³ /h	30"~42"
51240 (F112BS)	DN65	DN65	DN65	侧装, DN80上下布 Side-Mounted, DN80 Top and bottom strainer connector		40 m ³ /h	36"~48"

●F:内牙 M:外牙 OD:外径 ●F:Female M:Male OD:Outer Diameter

手动软化阀 Manual Softener Valve



结构性能特点 Structure Features

- 采用端面密封结构
- 可带压操作，再生时无硬水旁通
- 手动操作，360° 旋转
- F64BC、F64AC可侧面操作。
- Hermetic head faces structure.
- No hard water bypass and operating can happen on service.
- Start regeneration by manual, and handle can be rotated 360° cycle.
- F64BC, F64AC could be side-operated.

适用场合 Applications

- 家用软水系统 (F64A、F64AC、F64B、F64BC、F64C)
- 反渗透预处理的软水器
- 锅炉给水软化系统；离子交换设备
- Residential Softener System (F64A, F64AC, F64B, F64BC, F64C).
- Softener system for RO.
- Boiler softener system; Ion Exchange units.

专利号 (Patent No.) : ZL02220153.X、ZL200420062895.3、ZL200420078956.5、ZL200720045551.5

手动软化阀 Manual Softener Valve



产品型号 Product Model	进水口 Inlet	出水口 Outlet	排水口 Drain	基座 Base	中心管 Riser Pipe	吸盐口 Brine Tank Connector	产水量 Water Capacity	适配罐体 Tank Diameter Range for Softeners	再生方式 Regeneration Mode
61104 (F64A)	1"F	1"F	1/2"M	2.5"-8NPSM	1.05"OD	3/8"M	4.5m ³ /h	6"~18"	顺流DF
61204C (F64AC)	1"F	1"F	1/2"M	2.5"-8NPSM	1.05"OD	3/8"M	4.5m ³ /h	6"~18"	顺流DF
61202/71202 (F64B/F64C)	3/4"F	3/4"F	1/2"M	2.5"-8NPSM	1.05"OD	3/8"M	2 m ³ /h	6"~12"	F64B 顺流DF F64C 逆流UF
61202C (F64BC)	3/4"F	3/4"F	1/2"M	2.5"-8NPSM	1.05"OD	3/8"M	2 m ³ /h	6"~12"	顺流DF

●F:内牙 M:外牙 OD:外径 ●F:Female M:Male OD:Outer Diameter

备注: ●2.5" 及4" 基座可配备侧装连接件 ●F64A型提供金属及塑料材质两种手柄可选, 其它型号为塑料手柄
Remark: ●Side mount adapter available for 2.5" and 4" Base. ●Metal or plastic handle options for F64A.

专利号 (Patent No.) : ZL02220153.X、ZL200420062895.3、ZL200420078956.5、ZL200720045551.5

手动软化阀 Manual Softener Valve



产品型号 Product Model	进水口 Inlet	出水口 Outlet	排水口 Drain	基座 Base	中心管 Riser Pipe	吸盐口 Brine Tank Connector	产水量 Water Capacity	适配罐体 Tank Diameter Range for Softeners	再生方式 Regeneration Mode
61206 (N64F)	1.5"M	1.5"M	3/4"M	4"-8UN	1.25"D-GB	1/2"M	6 m ³ /h	10"~24"	顺流DF
61210 (N64D)	2"M	2"M	1"M	4"-8UN	1.5"D-GB 1.9"OD	1/2"M	10 m ³ /h	10"~30"	顺流DF
61215 (N77AS)	2"M	2"M	1.5"M	4"-8UN	1.5"D-GB 1.9" OD	3/4"M	15 m ³ /h	30"~40"	顺流DF
61240 (F112AS)	DN65	DN65	DN65	DN80 Top and bottom strainer connector	DN80 Top and bottom strainer connector	3/4"M	40 m ³ /h	48"~60"	顺流DF

●F:内牙 M:外牙 OD:外径 ●F:Female M:Male OD:Outer Diameter

备注:●2.5" 及4" 基座可配备侧装连接件 ●F64A型提供金属及塑料材质两种手柄可选, 其它型号为塑料手柄
Remark:●Side mount adapter available for 2.5" and 4" Base.●Metal or plastic handle options for F64A.

自动过滤阀

Automatic Filter Valve



结构性能特点 Structure Features

- 长期停电提示, 停电后数据保护功能 (可连续保持三天)
- 冲洗时无原水旁通
- 带有信号输出端口, 具有两种信号输出方式b-01(02)
- 可设定重复冲洗次数F-00, 即运行一次, 反洗、正洗多次
- 带远程控制端口, 可接收无源信号
- 具有互锁功能, 可用来做同时供水分别冲洗的系统
- 可选运行按天计与按小时计
- F77/F95/F111有两个阀芯, 一个控制进水、一个控制出水
- 有时间型和流量型可选
- Indication of long time power cut, data saved after power off (Saved for three days).
- No hard water bypass in rising cycle.
- Remote handling connector b-01(02).
- Backwash, fast rinse frequencies setting F-00, service one time, backwash and fast rinse several times.
- Remote signal input connector.
- Interlock function for contemporary system and individual rising.
- Start rising by days or hours.
- F77/F95/F111 have two valve cores, one is for controlling water in, the other is for out.
- Time type or meter type is for optional

适用场合 Applications

- 家用过滤系统 (F71/F67)
- 反渗透预处理的活性炭过滤器、砂过滤器
- Residential Filter System (F71B, F67B).
- A/C filter or sand filter system for RO pretreatment system.

专利号 (Patent No) : ZL02220153.X、ZL200420062895.3、ZL200420078956.5、ZL200720045551.5

自动过滤阀 Automatic Filter Valve



产品型号 Product Model	进水口 Inlet	出水口 Outlet	排水口 Drain	基座 Base	中心管 Riser Pipe	产水量 Water Capacity	适配罐体 Tank Diameter Range for Filters
53502 (F71B1)	3/4"M	3/4"M	3/4"M	2.5"-8NPSM	1.05"OD	2 m ³ /h	6"~10"
56603 (F67M)	3/4"M	3/4"M	3/4"M	2.5"-8NPSM	1.05"OD	3 m ³ /h	6"~10"
53502B (F71G1)	3/4"M	3/4"M	3/4"M	2.5"-8NPSM	1.05"OD	2 m ³ /h	6"~10"
53504S (F67B1)	1"F	1"F	1"F	2.5"-8NPSM	1.05"OD	4 m ³ /h	6"~16"
53506S (F67B-A)					1"D-GB	6 m ³ /h	

●F:内牙 M:外牙 OD:外径

●F:Female M:Male OD:Outer Diameter

●以上型号除53518(N77B)外, 均有流量型可选。

●There is meter type for option except the 53518(N77B).

专利号 (Patent No) : ZL02220153.X、ZL200420062895.3、ZL200420078956.5、ZL200720045551.5

自动过滤阀 Automatic Filter Valve



产品型号 Product Model	进水口 Inlet	出水口 Outlet	排水口 Drain	基座 Base	中心管 Riser Pipe	产水量 Water Capacity	适配罐体 Tank Diameter Range for Filters
53504 (F67C1)	1"F	1"F	1"F	2.5"-8NPSM	1.05"OD	4 m ³ /h	6" ~ 16"
53504B (F67G1)	1"F	1"F	1"F	2.5"-8NPSM	1.05"OD	4 m ³ /h	6" ~ 16"
53504C (F6711)	1"F	1"F	1"F	2.5"-8NPSM	1.05"OD	4 m ³ /h	6" ~ 16"
53508 (F134A)	1.5 "M	1.5 "M	1.5 "M	4"-8UN	1.25"D-GB 1.66 "OD	8 m ³ /h	24" ~ 30"

● F:内牙 M:外牙 OD:外径

● F:Female M:Male OD:Outer Diameter

● 以上型号除53518(N77B)外, 均有流量型可选。

● There is meter type for option except the 53518(N77B).

专利号 (Patent No) : ZL02220153.X、ZL200420062895.3、ZL200420078956.5、ZL200720045551.5

自动过滤阀 Automatic Filter Valve



产品型号 Product Model	进水口 Inlet	出水口 Outlet	排水口 Drain	基座 Base	中心管 Riser Pipe	产水量 Water Capacity	适配罐体 Tank Diameter Range for Filters
53510 (N75A1)	2"M	2"M	2"M	4"-8UN	1.5"D-GB 1.9"OD	10 m ³ /h	16"~24"
53510B (N75B1)	2"M	2"M	2"M	4"-8UN	1.5"D-GB 1.9"OD	10 m ³ /h	16"~24"
53515 (F99B1)	2"M	2"M	2"M	4"-8UN	1.5"D-GB 1.9"OD	15 m ³ /h	20"~30"
53518 (N77B1)	2"M	2"M	2"M	4"-8UN	1.5"D-GB 1.9"OD	18 m ³ /h	30"~36"

●F:内牙 M:外牙 OD:外径

●F:Female M:Male OD:Outer Diameter

●以上型号除53518(N77B)外, 均有流量型可选。

●There is meter type for option except the 53518(N77B).

专利号 (Patent No) : ZL02220153.X、ZL200420062895.3、ZL200420078956.5、ZL200720045551.5

自动过滤阀 Automatic Filter Valve



产品型号 Product Model	进水口 Inlet	出水口 Outlet	排水口 Drain	基座 Base	中心管 Riser Pipe	产水量 Water Capacity	适配罐体 Tank Diameter Range for Filters
53520 (F95B1)	2"M	2"M	2"M	4"-8UN	侧装 Side-Mounted	20 m ³ /h	30"~36"
53520T (F111B1)	2"M	2"M	2"M	4"-8UN	2"D-GB	20 m ³ /h	30"~36" 顶装 Top mounted
53540 (F112B1)	DN65	DN65	DN65	侧装, DN80上下布 Side-Mounted, DN80 Top and bottom strainer connector		40 m ³ /h	36"~48"
53550 (F96B1)	DN80	DN80	DN80	侧装, DN100上下布 Side-Mounted, DN100 Top and bottom strainer connector		50 m ³ /h	36"~48"

● F:内牙 M:外牙 OD:外径

● F:Female M:Male OD:Outer Diameter

● 以上型号除53518(N77B)外, 均有流量型可选。

● There is meter type for option except the 53518(N77B).

自动软化阀

Automatic softener Valve



结构性能特点 Structure Features

- 长期停电提示, 停电后当前时间数据保护功能 (可连续保持三天)
- 再生时无硬水旁通 (F92和F130除外)
- 带有信号输出端口; 带远程控制端口, 可接收无源信号
- 具有互锁功能, 可用来做同时供水分别再生的系统
- F77、F95、F111、F99采用球阀控制吸盐和补水
- 时间型有按天计与按小时计两种; 流量型有流量延滞型 (A-01) 、即时型 (A-02) 、智能流量延滞型 (A-03) 及智能流量即时型 (A-04) 四种, 可通过程序进行切换
- 逆流再生可设定反洗间隔次数F-00, 即运行多次、反洗一次
- F77、F95、F111有两个阀芯, 一个控制进水与吸盐、一个控制出水
- Indication of long time power cut, data saved after power off (Saved for three days).
- No hard water by pass in regeneration cycle.(Except F92 and F130).
- Signal output connector, remote handling connector could receive passive signal.
- Interlock function for contemporary system and individual regeneration.
- F77.F95.F111.F99 adopt ball valve for brine drawing and refill.
- Time clock regeneration option: by days or by hours; Meter valve regeneration option: Meter delayed(A-01), Meter immediate(A-02), Intelligent meter delayed(A-03), Intelligent meter immediate(A-04).
- Up-flow valve interval backwash times setting F-00, service several times, but backwash one time.
- F77.F95.F111 have two valve cores, one is for controlling water in and brine drawing, the other is for out.

适用场合 Applications

- 家用软水系统 (F63、F65、F68、F69)
- 反渗透预处理的软水器
- 锅炉给水软化系统
- 离子交换设备
- Residential Softener Systems (F63, F65, F68, F69).
- Softener for RO pretreatment System.
- Boiler Softening System, Ion-exchange system.

备注

- 型号带有S的表示有手轮手动功能。
- F77、F95、F111在运行程序内注水，采用电动球阀控制。
- F63、F65、F68、F69另有多种外观供选择。
- F74另有可顶装及侧装的控制盒供选择。
- 以上产品还有时间型，其型号表示如63504 (原型号F63C1)
- The model with a “S” means the valve with manual operation.
- F77.F95.F111 brine refilled while service, brine refilling controlled by electronic ball valve.
- F63, F65, F68 and F69 have a variety of appearances optional.
- Controller for F74 can be top or side mounted.
- The above products have time clock type, such as 63504 (Old model F63C1).

专利号 (Patent No.) : ZL02220153.X、ZL200420062895.3、ZL200420078956.5、ZL200720045551.5

自动软化阀 Automatic softener Valve



产品型号 Product Model	进水口 Inlet	出水口 Outlet	排水口 Drain	基座 Base	中心管 Riser Pipe	吸盐口 Brine Tank Connector	产水量 Water Capacity	适配罐体 Tank Diameter Range for Softeners	再生方式 Regeneration Mode
63604S (F63B3)	1"M	1"M	1/2"M	2.5"-8NPSM	1.05"OD	3/8"M	4 m ³ /h	10"~18"	顺流DF
63605 (F116A3)	1"M	1"M	3/4"M	2.5"-8NPSM	1.05"OD	3/8"M	5 m ³ /h	10"~20"	顺流DF F63升级款
63604 (F63C3)	1"M	1"M	1/2"M	2.5"-8NPSM	1.05"OD	3/8"M	4 m ³ /h	10"~18"	顺流DF
63604C (F63I3)	1"M	1"M	1/2"M	2.5"-8NPSM	1.05"OD	3/8"M	4 m ³ /h	10"~18"	顺流DF

● F:内牙 M:外牙 OD:外径 ● F:Female M:Male OD:Outer Diameter ● 以上型号均有时间型可选。 ● There is time type for option.

专利号 (Patent No.) : ZL02220153.X、ZL200420062895.3、ZL200420078956.5、ZL200720045551.5

自动软化阀 Automatic softener Valve







产品型号 Product Model	进水口 Inlet	出水口 Outlet	排水口 Drain	基座 Base	中心管 Riser Pipe	吸盐口 Brine Tank Connector	产水量 Water Capacity	适配罐体 Tank Diameter Range for Softeners	再生方式 Regeneration Mode
63604B (F63G3)	1"M	1"M	1/2"M	2.5"-8NPSM	1.05"OD	3/8"M	4 m ³ /h	10"~18"	顺流DF
63602 (F65B3)	3/4"F	3/4"F	1/2"M	2.5"-8NPSM	1.05"OD	3/8"M	2 m ³ /h	6"~12"	顺流DF
63603 (F117A3)	3/4"F	3/4"F	3/4"M	2.5"-8NPSM	1.05"OD	3/8"M	3 m ³ /h	10"~20"	顺流DF F65升级款
63602B (F65G3)	3/4"F	3/4"F	1/2"M	2.5"-8NPSM	1.05"OD	3/8"M	2 m ³ /h	6"~12"	顺流DF

● F:内牙 M:外牙 OD:外径 ● F:Female M:Male OD:Outer Diameter ● 以上型号均有时间型可选。 ● There is time type for option.

专利号 (Patent No.) : ZL02220153.X、ZL200420062895.3、ZL200420078956.5、ZL200720045551.5





自动软化阀 Automatic softener Valve

产品型号 Product Model	进水口 Inlet	出水口 Outlet	排水口 Drain	基座 Base	中心管 Riser Pipe	吸盐口 Brine Tank Connector	产水量 Water Capacity	适配罐体 Tank Diameter Range for Softeners	再生方式 Regeneration Mode
 73604 (F68C3)	1"M	1"M	1/2"M	2.5"-8NPSM	1.05"OD	3/8"M	4 m ³ /h	10"~18"	逆流UF
 73604S (F68A3)	1"M	1"M	1/2"M	2.5"-8NPSM	1.05"OD	3/8"M	4 m ³ /h	10"~18"	逆流UF
 73602 (F69A3)	3/4"F	3/4"F	1/2"M	2.5"-8NPSM	1.05"OD	3/8"M	2 m ³ /h	6"~12"	逆流UF
 73605 (F92A3)	1"M	1"M	NPT3/4	2.5"-8NPSM	1"D-GB	3/8"M	5 m ³ /h	7"~22"	逆流UF

● F:内牙 M:外牙 OD:外径 ● F:Female M:Male OD:Outer Diameter ● 以上型号均有时间型可选。 ● There is time type for option.

专利号 (Patent No.) : ZL02220153.X、ZL200420062895.3、ZL200420078956.5、ZL200720045551.5

自动软化阀 Automatic softener Valve

产品型号 Product Model	进水口 Inlet	出水口 Outlet	排水口 Drain	基座 Base	中心管 Riser Pipe	吸盐口 Brine Tank Connector	产水量 Water Capacity	适配罐体 Tank Diameter Range for Softeners	再生方式 Regeneration Mode
 63605 (F130A3)	1"M	1"M	NPT3/4	2.5"-8NPSM	1"D-GB	3/8"M	6 m ³ /h	7" ~ 22"	顺流DF
 63508 (F133A)	1.5" M	1.5" M	3/4" M	4"-8UN	1.25"D-GB 1.66 "OD	1/2" M	8 m ³ /h	24" ~ 30"	顺流DF
 63610 (N74A3)	2" M	2" M	1" M	4"-8UN	1.5"D-GB 1.9"OD	1/2" M	10 m ³ /h	20" ~ 30"	顺流DF
 63615 (F99A3)	2" M	2" M	1.5" M	4"-8UN	1.5"D-GB 1.9"OD	3/4" M	15 m ³ /h	30" ~ 40"	顺流DF





485通信端口
with 485 Connector

新品
* NEW *

● F:内牙 M:外牙 OD:外径 ● F:Female M:Male OD:Outer Diameter ● 以上型号均有时间型可选。 ● There is time type for option.

专利号 (Patent No.) : ZL02220153.X、ZL200420062895.3、ZL200420078956.5、ZL200720045551.5

自动软化阀 Automatic softener Valve

产品型号 Product Model	进水口 Inlet	出水口 Outlet	排水口 Drain	基座 Base	中心管 Riser Pipe	吸盐口 Brine Tank Connector	产水量 Water Capacity	适配罐体 Tank Diameter Range for Softeners	再生方式 Regeneration Mode
 73615 (F99D3)	2"M	2"M	1.5"M	4"-8UN	1.5"D-GB 1.9"OD	3/4"M	15 m ³ /h	30" ~ 40"	逆流UF
 63618 (N77A3)	2"M	2"M	1.5"M	4"-8UN	1.5"D-GB 1.9"OD	3/4"M	18 m ³ /h	30" ~ 40"	顺流DF
 63620 (F95A3)	2"M	2"M	1.5"M	2"M(上下布) Top and bottom strainer		3/4"M	20 m ³ /h	36" ~ 48"	顺流DF 侧装 Side mounted
 63620T (F111A3)	2"M	2"M	1.5"M	4"-8UN	2"D-GB	3/4"M	20 m ³ /h	36" ~ 48"	顺流DF 顶装 Top mounted

● F:内牙 M:外牙 OD:外径 ● F:Female M:Male OD:Outer Diameter ● 以上型号均有时间型可选。 ● There is time type for option.

专利号 (Patent No.) : ZL02220153.X、ZL200420062895.3、ZL200420078956.5、ZL200720045551.5

自动软化阀 Automatic softener Valve

产品型号 Product Model	进水口 Inlet	出水口 Outlet	排水口 Drain	基座 Base	中心管 Riser Pipe	吸盐口 Brine Tank Connector	产水量 Water Capacity	适配罐体 Tank Diameter Range for Softeners	再生方式 Regeneration Mode
63650 F96A3	DN80	DN80	DN80	DN100(上下布) Top and bottom strainer		3/4"M	50 m ³ /h	60" ~ 72"	顺流DF
63640 (F112A3)	DN65	DN65	DN65	DN80(上下布) Top and bottom strainer		3/4"M	40 m ³ /h	48" ~ 60"	顺流DF

●F:内牙 M:外牙 OD:外径 ●F:Female M:Male OD:Outer Diameter ●以上型号均有时间型可选。 ●There is time type for option.

连续供水用多功能控制阀

One Valve On Duplex Tanks for Water Treatment Systems



结构性能特点 Structure Features

- 陶瓷阀芯、端面密封结构
 - 一个阀门控制两只罐体，一用一备
 - 再生罐置换洗后待机，切换前正洗
 - 流量启动再生
 - 有两个阀芯，一个实现两个罐体的切换，一个控制再生
 - 除F73外其余都是软水再生与侧装方式
- Ceramic valve core, hermetic head faces structure.
 - One valve on twin tanks, one is on service and the other is standby.
 - Regeneration tank standby after exchange, fast rinse before service.
 - Regeneration start type: Meter type only.
 - Two valve cores, one is for tanks switching, the other is for regeneration.
 - It is side-mounted and uses soft water for regeneration, except F73.

适用场合 Applications

- 适用于要求连续供应软化水的场合
- Continuous Soft Water Supplying.

专利号 (Patent No.) : ZL02220153.X、ZL200620108858.0

连续供水用多功能控制阀 One Valve On Duplex Tanks for Water Treatment Systems

产品型号 Product Model	进水口 Inlet	出水口 Outlet	排水口 Drain	基座 Base	中心管 Riser Pipe	吸盐口 Brine Tank Connector	产水量 Water Capacity	适配罐体 Tank Diameter Range for Softeners	再生方式 Regeneration Mode
17603 (F73)	1"M	1"M	1/2"M	2.5"-8NPSM	2×1.05"OD	3/8"M	3.5 m ³ /h	10" ~ 14"	顺逆流 DF/UF
18604B (F118B)	G1	G1	NPT3/4	2.5"-8NPSM	1.05"OD	3/8"M	4 m ³ /h	12" ~ 18"	顺逆流 DF/UF 软水再生 Soft Water for Regeneration
17606 (F98A)	1"M	1"M	3/4"M	1"M (上下布) Top and bottom strainer		1/2"M	6 m ³ /h	20" ~ 24"	逆流UF 侧装 Side mounted
17610 (F88A)	1.5"M	1.5"M	1"M	1.5"M (上下布) Top and bottom strainer		1/2"M	10 m ³ /h	20" ~ 30"	逆流UF 侧装 Side mounted

●F:内牙 M:外牙 OD:外径 ●F:Female M:Male OD:Outer Diameter

专利号 (Patent No.) :ZL02220153.X、ZL200620108858.0

5-6 m³/h 一用一备软水系统

One In Service One Standby Softening System(5-6 m³/h)

应用范围

- 适用于5-6 m³/h连续供水场合

系统构成

- 两台F92A3/F130A3+DN32三通电动球阀（四芯插头）

连接

- 两台F92A3/F130A3互锁，并设置为C-02(一用一备连接)

Application Range:

Suitable for 5-6m³/h Continuous Water Supplying

System Constitution:

Two F92A3/F130A3 and DN25 Three-way Electronic Ball Valve (Four Core Plug)

Connection:

Two F92A3/F130A3 are interlocked as one system, and set c-02 (a connection for one in service one standby softening system).

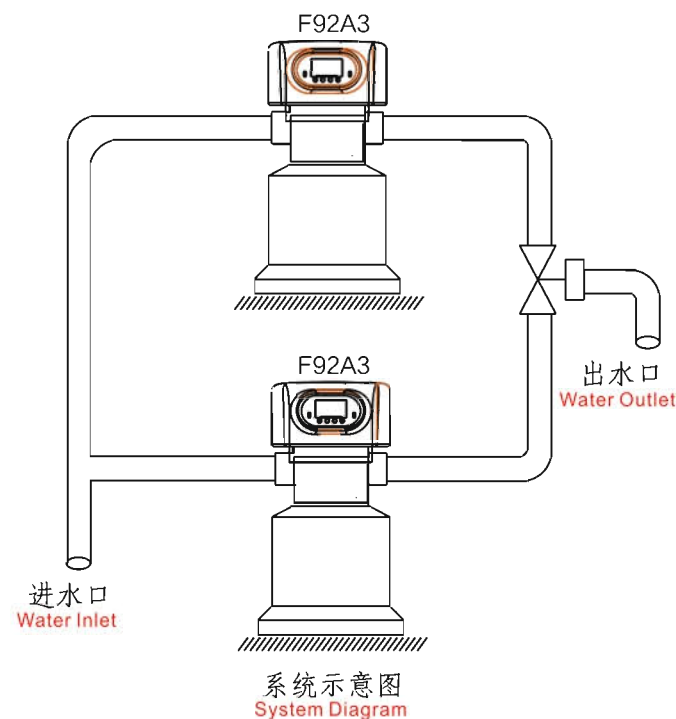

10-20 m³/h 一用一备软水系统

One In Service One Standby Softening System(10-20m³/h)

应用范围

- 适用于10-20m³/h连续供水场合

系统构成

- 两台F74A3/F99A3/F95A3/F111A3+F80

连接

- 两台阀互锁，程序设置为A-02和b-01;
- 将控制阀的信号输出端口与F80的控制线相连

应用

- 当出水阀的流量减为0时，控制阀再生，信号输出端口控制F80换向，另一台阀出水;
- 如另一台阀处于再生，由于互锁作用，出水阀继续出水。

Application Range:

Suitable for 10-20m³/h Continuous Water Supplying

System Constitution:

Two F74A3/F99A3/F95A3/F111A3 and F80

Connection:

Two valves are interlocked as one system, and set the system to A-02 and b-01; Connect the signal outlet connector with the control wire of F80.

Application:

When the flow of working valve reduces to 0, the control valve regenerates, F80 switches by the signal outlet connector controlling, the other valve turns to service. If the other valve is in regeneration, because of the function of interlock, the working valve still works.

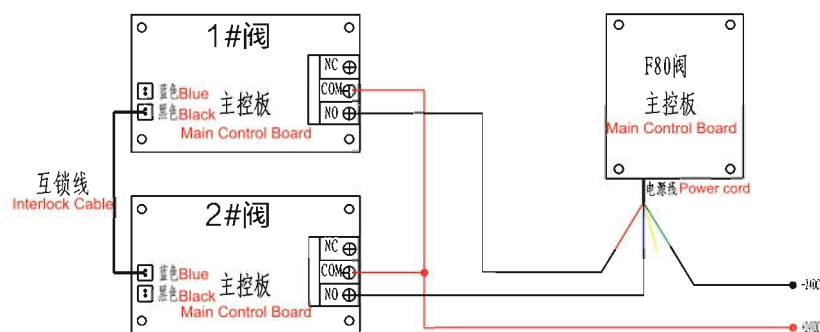

一用一备系统接线图

The Wring for One in Service one Standby



40-50 m³/h 一用一备软水系统

One In Service One Standby Softening System(40-50m³/h)

应用范围

- 适用于40-50m³/h连续供水场合

系统构成

- 两台F112A3/F96A3+两台DN25球阀

连接

- 两台阀连接一用一备信号线（即原互锁线）；
- 程序设置为C-02（一用一备）；

备注

- 常规F112A3/F96A3需更换吸盐铜管，加装DN25球阀
- 程序设置为C-02（一用一备）；

应用

- 连续供水，一台供水，另一台等待供水

Application Range:

Suitable for 40-50m³/h Continuous Water Supplying

System Constitution:

Two F112A3/F96A3 and Two DN25 Electronic Ball Valves

Connection:

Two valves are connected to signal line of one in service and one standby system (interlock wire), and set the system to C-02 (One in Service One Standby System).

Note:

Ordinary F112A3/F96A3 needs to replace brine draw copper tube, and install DN25 ball valve with it.

Application:

Continuous water supplying, one valve in service, the other valve standby.



两用一备连续供水多功能控制阀

Two in service one standby continuously water supplying control valve

- 一个阀控制三个罐，两罐串联运行，另一罐再生或备用，连续供水不中断。
- 运行终点时，串联的第一级转入再生、第二级作为第一级、再生好备用的交换罐作为第二级串联运行，可大大提高树脂的利用率、省盐省水。
- 再生罐置换后待机，切换前正洗。
- 只需一只盐箱。
- 采用端面陶瓷密封结构，密封可靠，经久耐用。
- 可通过程序选择顺流或逆流再生。
- 更换主动阀片，可实现用原水再生或用软水再生。
- 去掉一个罐，就可以转变成一用一备连续软化供水系统。
- 始终有两罐串联供水，可处理高硬度的原水。具有反冲洗功能，解决浮动床不能用于原水浊度较高的场合。
- One valve controls three tanks, two tanks supply with softened water in series, the other tank standby to achieve water supply continuously.
- When service finishes, the first grade in series turns to regenerate, the second grade turns to the first grade and supplies with softened water together with the standby tank as the second grade in series, which greatly improves the resin efficiency, saves water and salt.
- Regeneration tank keeps standby after switch and starts fast rinse before service.
- Only need one brine tank.
- It adopts hermetic head faces structure with ceramic sealing, reliable and duration.
- Up-flow or down-flow regeneration is optional by program.
- Raw water or softened water for regeneration is optional by changing the moving disk.
- Remove one tank to make the system as one in service one standby system.
- There is always having two tanks in service in series which could treat the raw water with high hardness. It has backwash function, which could be used in high turbidity application which floating bed system can't be used.
- 适用于高硬度水质连续供水场合
- Suitable for treat big hardness water continuous supplying application

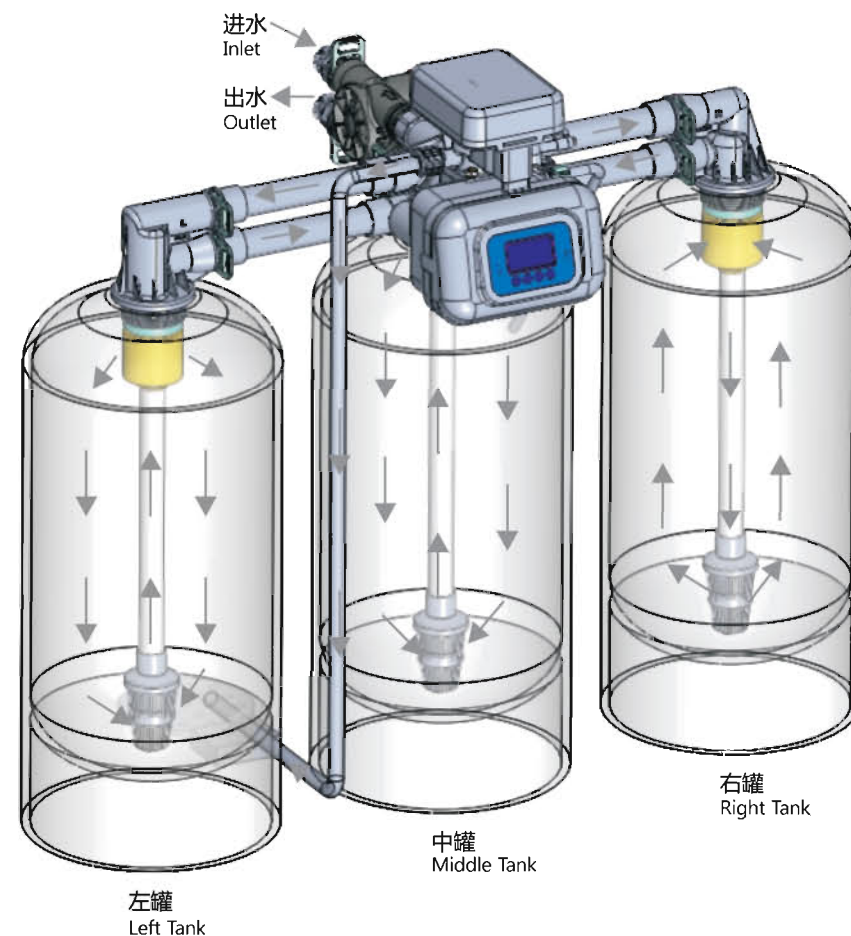



产品型号 Product Model	进/出水口 Inlet/Outlet	排水口 Drain	基座 Base	中心管 Riser Pipe	吸盐口 Brine Tank Connector	产水量 Water Capacity	适配罐体 Tank Diameter Range for Softeners	再生方式 Regeneration Mode
18604A(F118A) 18604B(F118B)	G1	NPT3/4	3×2.5"-8NPSM	3×1.05"OD (Ø26.7)	G3/8	4 m ³ /h	10"~18"	F118A原水 F118A Raw water F118B 软水 F118B Soft water
18601B(F120B)	G3/4	NPT3/4	3×2.5"-8NPSM	3×1.05"OD (Ø26.7)	G3/8	1.5 m ³ /h	10"~12"	软水 Soft water

●F:内牙 M:外牙 OD:外径 ●F:Female M:Male OD:Outer Diameter

应用说明:

- 利用润新阀自带的信号输出常开端口分别控制三通球阀两种状态的工作电源;
- 当出水阀的流量减为0时, 控制阀再生, 信号输出端口控制三通球阀换位, 另一只阀出水;
- 如果此时另一只阀正在再生, 由于互锁的作用, 出水阀继续出水。

Application:

- By using normal open signal output function on RUNXIN control valve to control the power of three-way ball valve's two status.
- When the volume of the service valve reduces to 0, the control valve will turn to regeneration status, the signal output connector controls three-way ball valve to change its position, and the other valve turns to service status.
- If the other valve is in regeneration status at this time, as the interlock function, the service valve has to keep supplying water.

P系列控制阀(简易阀)

P Series Control Valve



结构性能特点 Structure Features

- 由一个光耦来定位，F63P、F67P、F68P定位板通用，F65P、F69P、F71P定位板通用，通用性强。各主板可通过程序来调节各型号
- 端面密封结构，再生或冲洗时无原水旁通。
- 停电后再来电，程序先转一圈后停在原来位置。
- 更简单、更经济
- 指示灯显示
- Locate by optocoupler, more stable performance. F63P, F67P and F68P adopt the same locating board, while F65P, F69P and F71P use the same locating board. They all use the same main control board.
- Hermetic head faces structure, no hard water bypass when regeneration cycle.
- When electrical service recover, program run one cycle then locate at the previous position.
- Cheaper and simpler.
- Indicator display

适用场合 Applications

- 家用软水系统或过滤系统
- 锅炉给水软化系统、离子交换设备
- Residential Softener or Filter system.
- Boiler Softener, Ion-Exchange Equipment.

专利号 (Patent No.) :201300326848.4

P系列控制阀(简易阀) P Series Control Valve

产品型号 Product Model	进水口 Inlet	出水口 Outlet	排水口 Drain	基座 Base	中心管 Riser Pipe	吸盐口 Brine Tank Connector	产水量 Water Capacity	适配罐体 Tank Diameter Range for Softeners	再生方式 Regeneration Mode
 54502 (F71P1)	3/4"M	3/4"M	3/4"M	2.5"-8NPSM	1.05"OD	—	2 m ³ /h	6"~10"	过滤Filter
 54504 (F67P1)	1"F	1"F	1"F	2.5"-8NPSM	1.05"OD	—	4 m ³ /h	6"~16"	过滤Filter
 64502 (F65P1) 64602 (F65P3)	3/4"M	3/4"M	1/2"M	2.5"-8NPSM	1.05"OD	3/8"M	2 m ³ /h	6"~12"	顺流DF
 64504 (F63P1) 64604 (F63P3)	1"M	1"M	1/2"M	2.5"-8NPSM	1.05"OD	3/8"M	4 m ³ /h	10"~18"	顺流DF

●F:内牙 M:外牙 OD:外径 ●F:Female M:Male OD:Outer Diameter

专利号 (Patent No.) :201300326848.4

P系列控制阀(简易阀) P Series Control Valve



产品型号 Product Model	进水口 Inlet	出水口 Outlet	排水口 Drain	基座 Base	中心管 Riser Pipe	吸盐口 Brine Tank Connector	产水量 Water Capacity	适配罐体 Tank Diameter Range for Softeners	再生方式 Regeneration Mode
74502 (F69P1) 74602 (F69P3)	3/4" M	3/4" M	1/2" M	2.5"-8NPSM	1.05" OD	3/8" M	2 m ³ /h	6"~12"	逆流UF
74504 (F68P1) 74604 (F68P3)	1" M	1" M	1/2" M	2.5"-8NPSM	1.05" OD	3/8" M	4 m ³ /h	10"~18"	逆流UF

P系列控制阀带485通信端口 P series Control Valve with 485 Connector



- 带485通信端口
- with 485 Connector
- 带远程控制端口
- With remote handling connector

升级版
Upgraded version





结构性能特点 Structure Features

- 主控板与显示板合并为一
 - 四位数码管显示
 - 互锁、信号输出功能
 - 断电数据记忆功能
- Integrate main board and display board on one board.
 - Four digital display.
 - Has interlock connector.
 - Has signal output connector.
 - Parameters will be saved after power off.

超高性价比







Competitive price
with good performance

适用场合 Applications

- 家用软水系统或过滤系统
- 锅炉给水软化系统、离子交换设备
- Residential Softener or Filter system.
- Boiler Softener, Ion-Exchange Equipment.

专利号 (Patent No.) :201300326848.4

Q系列控制阀(简易阀) Q Series Control Valve

产品型号 Product Model	进水口 Inlet	出水口 Outlet	排水口 Drain	基座 Base	中心管 Riser Pipe	吸盐口 Brine Tank Connector	产水量 Water Capacity	适配罐体 Tank Diameter Range for Filters
 <u>55502/55602</u> (F71Q1/F71Q3)	3/4"M	3/4"M	3/4"M	2.5"-8NPSM	1.05"OD	/	2 m ³ /h	6"~10"
 <u>55504/55604</u> (F67Q1/F67Q3)	1"F	1"F	1"F	2.5"-8NPSM	1.05"OD	/	4 m ³ /h	6"~18"
 <u>65503/65603</u> (F117Q1/F117Q3)	3/4"F	3/4"F	3/4"NPT	2.5"-8NPSM	1.05"OD	3/8"M	3 m ³ /h	10"~20"
 <u>65505/65605</u> (F116Q1/F116Q3)	1"M	1"M	3/4"NPT	2.5"-8NPSM	1.05"OD	3/8"M	5 m ³ /h	10"~20"
 <u>75502(F69Q1)</u> <u>75602(F69Q3)</u>	3/4"M	3/4"M	3/4"NPT	2.5"-8NPSM	1.05"OD	3/8"M	2 m ³ /h	6"~12"
 <u>75504(F68Q1)</u> <u>75604(F68Q3)</u>	1"M	1"M	3/4"NPT	2.5"-8NPSM	1.05"OD	3/8"M	4 m ³ /h	10"~18"

●F:内牙 M:外牙 OD:外径

●F:Female M:Male OD:Outer Diameter

家用系列控制阀(LCD)

Residential Softener
of D Series (LCD Display)



侧控阀(F122A3)
Side control valve

产品型号 Product Model	进/出水口 Inlet/Outlet	排水口 Drain	吸盐口 Brine Tank Connector	基座 Base	中心管 Riser Pipe	产水量 Water Capacity	配套罐体 (in) Tank Diameter Range for Softeners	备注 Remarks
63502C F122A1	3/4"F	活接 Animated Connector	3/8"M	2.5"-8NSM	1.05"-OD	2	7"-14"	时间型 Time Clock Type
63602C F122A3	3/4"F		3/8"M	2.5"-8NSM	1.05"-OD	2	7"-14"	流量型 Meter Type

●F:内牙 M:外牙 OD:外径 ●F:Female M:Male OD:Outer Diameter

结构性能特点 Structure Features

- LCD显示, 直观, 方便
 - 长期停电提示, 停电后当前时间数据保护功能 (可连续保持三天)
 - 设置逆流再生时, 可设定反洗间隔次数F-00, 即运行多次、反洗一次
 - F79、F82可在程序中选择顺流或逆流, 带部分旁通功能
 - 带消毒接口, 软化阀再生时可电解吸入的盐水进行消毒
 - 带缺盐报警信号端口, 与缺盐报警装置连接, 缺盐时可报警
 - D系列阀(F63D等)程序分用户设置及后台设置, 防止误操作
 - F105、F97补软水, 顺逆流再生, 可设计为度假模式及干盐箱模式
 - F105、F79具有防泄漏保护功能, F105具有按产水比例吸盐再生功能
- LCD display, intuitional and convenient.
 - Indication of long time power cut, data saved after power off(Saved for three days.)
 - Up-flow valve interval backwash times setting F-00, service several times, but backwash one time.
 - Down-flow or Up-flow option can be set in the program, and also can mix hard water to the system if required not too soft water.
 - Disinfection connector. Electrolyze brine in regeneration to disinfect. Salt Shortage Alarm connector.
 - D series valve has foreground and background operation to prevent incorrect operation.
 - F105 and F97 use soft water for brine refilling, both UF and DF option, have vacation mode and dry brine mode.
 - F105 and F79 has the leakage protection function; F105 has the function of proportionally brine draw and brine refill based on the percentage of real capacity

适用场合 Applications

- 家用软水系统或中央软水系统
- 反渗透预处理的软水器
- Residential Softener or the Whole House Water Softener.
- RO Pre-treatment Softener.

专利号 (Patent No.) : ZL02257746.7、ZL02220153.X、ZL200420062895.3、ZL200420078956.5、ZL200



家用系列控制阀(LCD) Residential Softener of D Series (LCD Display)

产品型号 Product Model	进水口 Inlet	出水口 Outlet	排水口 Drain	基座 Base	中心管 Riser Pipe	吸盐口 Brine Tank Connector	产水量 Water Capacity	适配罐体 Tank Diameter Range for Softeners	再生方式 Regeneration Mode
 52502 (F71D1)	3/4"M	3/4"M	1/2"M	2.5"-8NPSM	1.05"OD	—	2 m ³ /h	6"~10"	过滤Filter
 52504 (F67D1)	1"M	1"M	1/2"M	2.5"-8NPSM	1.05"OD	—	4 m ³ /h	6"~12"	过滤Filter
 <u>62502/62602</u> <u>F65D1/F65D3</u>	3/4"M	3/4"M	1/2"M	2.5"-8NPSM	1.05"OD	3/8"M	2 m ³ /h	6"~12"	顺流DF
 <u>62504/62604</u> <u>F63D1/F63D3</u>	1"M	1"M	1/2"M	2.5"-8NPSM	1.05"OD	3/8"M	4 m ³ /h	6"~18"	顺流DF

●F:内牙 M:外牙 OD:外径 ●F:Female M:Male OD:Outer Diameter

专利号 (Patent No.) : ZL02257746.7、ZL02220153.X、ZL200420062895.3、ZL200420078956.5、ZL200

家用系列控制阀(LCD) Residential Softener of D Series (LCD Display)

产品型号 Product Model	进水口 Inlet	出水口 Outlet	排水口 Drain	基座 Base	中心管 Riser Pipe	吸盐口 Brine Tank Connector	产水量 Water Capacity	适配罐体 Tank Diameter Range for Softeners	再生方式 Regeneration Mode
 72504/72604 F68D1/F68D3	1"M	1"M	1/2"M	2.5"-8NPSM	1.05"OD	3/8"M	4 m ³ /h	6"~16"	逆流UF
 72502/72602 F69D1/F69D3	3/4"M	3/4"M	1/2"M	2.5"-8NPSM	1.05"OD	3/8"M	2 m ³ /h	6"~12"	逆流UF
 82602 (F79A)	3/4"M	3/4"M	1/2"M	2.5"-8NPSM	1.05"OD	3/8"M	2 m ³ /h	6"~12"	顺逆流 DF/UF
 82602B (F79B)	3/4"M	3/4"M	1/2"M	2.5"-8NPSM	1.05"OD	3/8"M	2 m ³ /h	6"~12"	硬水旁通 Hard water by passing

●F:内牙 M:外牙 OD:外径 ●F:Female M:Male OD:Outer Diameter

专利号 (Patent No.) : ZL02257746.7、ZL02220153.X、ZL200420062895.3、ZL200420078956.5、ZL200

家用系列控制阀(LCD) Residential Softener of D Series (LCD Display)

产品型号 Product Model	进水口 Inlet	出水口 Outlet	排水口 Drain	基座 Base	中心管 Riser Pipe	吸盐口 Brine Tank Connector	产水量 Water Capacity	适配罐体 Tank Diameter Range for Softeners	再生方式 Regeneration Mode
 82604 (F82A)	1"M	1"M	1/2"M	2.5"-8NPSM	1.05"OD	3/8"M	3.5 m ³ /h	6"~16"	顺逆流 DF/UF
 82604B (F82B)	1"M	1"M	1/2"M	2.5"-8NPSM	1.05"OD	3/8"M	3.5m ³ /h	6"~16"	硬水旁通 Hard water by passing
 82602E (F105A3)	3/4"M	3/4"M	1/2"M	2.5"-8NPSM	1.05"OD	3/8"M	2 m ³ /h	6"~12"	顺逆流 DF/UF
 82604E (F97A3)	3/4"M	3/4"M	1/2"M	2.5"-8NPSM	1.05"OD	3/8"M	4 m ³ /h	6"~18"	顺逆流 DF/UF

●F:内牙 M:外牙 OD:外径 ●F:Female M:Male OD:Outer Diameter



浮动床用控制阀

Control Valve for Floating Bed Water Treatment Systems



结构性能特点 Structure Features





- F112采用压力驱动活塞式，其它型号采用端面密封结构。
- F88、F98一个阀门控制两只罐体，一用一备。
- F83、F77CS、F112CS为硬水再生，其他为软水再生。
- 采用逆流运行—吸盐再生—补水—正洗的浮动床运行工艺。
- Hermetic head faces structure (F112 has piston structure)
- One valve on twin tanks, one in service, the other standby.(F88 and F98)
- F83, F77CS and F112CS are hard water for regeneration, others are soft water for regeneration.
- Adopt the technological process of up-flow service --brine draw--brine refill--fast rinse.

适用场合 Applications

- 适用于原水硬度小于15mmol/L等高硬度水处理的场合
- Suitable for high hardness(Less than 15mmol/L) water treatment applications.

专利号 (Patent No.) : ZL02220153.X、ZL200420078956.5、ZL200620108858.0、ZL200720045551.5

浮动床用控制阀 Control Valve for Floating Bed Water Treatment Systems

产品型号 Product Model	进水口 Inlet	出水口 Outlet	排水口 Drain	基座 Base	中心管 Riser Pipe	吸盐口 Brine Tank Connector	产水量 Water Capacity	适配罐体 Tank Diameter Range for Softeners	再生方式 Regeneration Mode
 93604 (F83A3)	1"M	1"M	1/2"M	2.5"-8NPSM	1.05"OD	3/8"M	4 m ³ /h	10" ~ 14"	硬水再生 Regeneration with hardwater
 93606 (F98C)	1"M	1"M	3/4"M	1"M (上下布) Top and bottom strainer		1/2"M	6 m ³ /h	18" ~ 24"	一阀双罐 连续供水 One valve on duplex tanks
 93610 (F88C)	1.5"M	1.5"M	1"M	1.5"M (上下布) Top and bottom strainer		1/2"M	10 m ³ /h	20" ~ 24"	一阀双罐 连续供水 One valve on duplex tanks
 91215 (F77CS)	2"M	2"M	1.5"M	4"-8UN	1.5"D-GB 1.5"OD	3/4"M	15 m ³ /h	20" ~ 30"	硬水再生 Regeneration with hard water

●F:内牙 M:外牙 OD:外径 ●F:Female M:Male OD:Outer Diameter

专利号 (Patent No.) : ZL02220153.X、ZL200420078956.5、ZL200620108858.0、ZL200720045551.5

浮动床用控制阀 Control Valve for Floating Bed Water Treatment Systems



产品型号 Product Model	进水口 Inlet	出水口 Outlet	排水口 Drain	基座 Base	中心管 Riser Pipe	吸盐口 Brine Tank Connector	产水量 Water Capacity	适配罐体 Tank Diameter Range for Softeners	再生方式 Regeneration Mode
93620 (F95C3)	2"M	2"M	1.5"M	2"M(上下布) Top and bottom strainer		3/4"M	20 m ³ /h	30" ~ 36"	软水再生 Regeneration with soft water
91240 (F112CS)	DN65	DN65	DN65	DN80(上下布) Top and bottom strainer		3/4"M	40 m ³ /h	36" ~ 48"	硬水再生 Regeneration with hard water
93640 (F112C3)	DN65	DN65	DN65	DN80(上下布) Top and bottom strainer		3/4"M	40 m ³ /h	36" ~ 48"	软水再生 Regeneration with soft water

●F:内牙 M:外牙 OD:外径 ●F:Female M:Male OD:Outer Diameter

专利号 (Patent No.) : ZL02220153.X、ZL200420078956.5、ZL200620108858.0、ZL200720045551.5

旁通阀系列 Bypass Valve Series



产品型号 Product Model	进水口 Inlet	出水口 Outlet	配套控制阀管径 Valve Size	配套控制阀中心距 Inlet Outlet Distance	备注 Remark
41104 (F70A)	1"M	1"M	1"F	50mm	F70A适配F63/F68控制阀 Suited F63/F68 Valve
41102 (F70B)	3/4"M	3/4"M	3/4"M	65/70mm可调	F70B专配F65/F69控制阀 Suited F65/F69 Valve
41204 (F70C)	1"M	1"M	1"F	50mm	F70C专配F63/ F68/F82控制阀 Suited F63/F68/ F82 Valve
41102 (F70D)	3/4"M	3/4"M	3/4"M	50mm	F70D专配F79控制阀 Suited F79 Valve

专利号 (Patent No.) : ZL02220153.X、ZL200420078956.5、ZL200620108858.0、ZL200720045551.5

旁通阀系列 Bypass Valve Series



产品型号 Product Model	进水口 Inlet	出水口 Outlet	配套控制阀管径 Valve Size	配套控制阀中心距 Inlet Outlet Distance	备注 Remark
41206 (F70F)	1"M		NPT 1"或1"M	50mm	F70F专配F92/F97控制阀 Suited F92/F97 Valve
41304 (F70G)	NPT 3/4"M 或1"M或NPT 1"M		3/4"M或1"M 或NPT 1"M	50mm	F70G专配F63/F68/ F79/F82/F105控制阀 Suited F63/F68/F79/ F82/F105Valve
41302 (F70H)	3/4"M		3/4"M	50mm	适配F67N/F122控制阀 Suited with F67N/F122
41103 (F70I)	1"M		1"M	50mm	F70I 适配F79控制阀 Suited with F79BD

特殊控制阀系列 Special Control Valve Series

除铁/锰装置

Iron and Manganese Removal Device



F107



F107C

型号 Model	出水水质 Outlet Water Quality	含锰量 Manganese Containing	出水浊度 Outlet Water Turbidity	进水水质 Inlet Water Quality		型号 Model	进水浊度 Inlet Water Turbidity	碱度 Alkalinity	pH值 pH Value	水温 Water Temperature	产水量m ³ /h Water capacity
F107	含铁量: ≤0.3mg/L Iron Containing: ≤0.3mg/L	≤0.1mg/L	<5mg/L	含铁量: ≤20mg/L Iron Containing: ≤20mg/L	含锰量: ≤3mg/L Manganese Containing: ≤3mg/L	F107	<15mg/L	≤2mg/L	6.8 ~ 9	6 ~ 10℃	2
F107C	含铁量: ≤0.3mg/L Iron Containing: ≤0.3mg/L	≤0.1mg/L	<5mg/L	含铁量: ≤20mg/L Iron Containing: ≤20mg/L	含锰量: ≤3mg/L Manganese Containing: ≤3mg/L	F107C	<15mg/L	≤2mg/L	6.8 ~ 9	6 ~ 10℃	10

在线取样检测出水硬度装置 On-line Sampling Monitor Device

结构性能特点 Structure Features

- 采用固定容积的动片通孔及混合腔取试剂及水样，一致性好；
- 多种计时模式可选：a) 可根据水质要求设定检测周期，范围：0-300分钟；b)、输入树脂体积、原水硬度及平均每小时用水量等参数，系统自动计算运行总时间；
- 设置简单：只需设置检测间隔时间（检测周期），其他工位程序默认时间；
- 试剂用完后系统会报警，并将程序转为时间型按小时计，直至添加试剂。
- Using constant volume for through-holes and mixing chamber, good consistency for water sample testing;
- Several time modes optional:a).It can adjust the monitoring time according to the water quality:0-300minutes;b).Input the resin volume, water hardness and the average water consumption per hours, the system will calculate the operate time automatically;
- Easy to set up: Only need to set the test interval time (Detection period), others set as the default time;
- The system will alarm when the reagent exhausted and turn the time mode program by hours until add reagent;

适用场合 Applications

对软化阀出水硬度进行检测，并根据设定的程序发出信号。适用于蒸汽锅炉、热水锅炉及对水质硬度控制要求较高的软化水处理系统。

Test treated water hardness on outlet of softener valve, depending on the test result to control the softener valve regeneration. Suitable for softening water treatment system which has a high requirement for treated water application, steam boiler and hot water boiler application.



44710 (F84)

型号 Model	进水口 Inlet	出水口 Outlet	取样口 Sampling Connection	流量计进水口 Flow meter inlet	流量计出水口 Flow meter drain
44710	Φ6气管快接 Φ 6 gas-type fitting	Φ8气管快接 Φ 8 gas-type fitting	Φ6气管快接 Φ 6 gas-type fitting	1"F	1"M

●F:内牙 M:外牙 ●F:Female M:Male



2-4 m³/h

RXH02/RXH04



2 m³/h

15702(F86)



4 m³/h

15704(F87)

混床用控制阀 Control Valve for Mixed Bed

结构性能特点 Structure Features

- LED显示, 带信号输出端口、远程控制输入、键盘锁等功能
- 可通过程序控制实现再生过程中采用一级除盐水或二级除盐水的切换。
- 反洗末期多次间隔通断水, 提高阴阳树脂分层效果
- 运行位停用或停电后再启用进入正洗
- 出水口安装电阻率仪, 当出水电阻率不合格时, 可立即启动再生。
- LED display, remote signal input, keyboard lock and other functions.
- Use first or second grade demineralized water to regenerate could be switched in program.
- Multi-times of connect and disconnect water at the end of backwash to improve the effect of layering of anion and cation resin.
- No water used, valve could wait in service position. If power cut, valve goes to fast rinse after power on.
- Resistivity on outlet. When outlet water is disqualified, it will regenerate automatically.

适用场合 Applications

- 用于将阴、阳离子交换树脂混合在同一个交换器的混床精除盐水处理系统
- Mixed Cation/Anion Resin Bed Desalination System.

型号 Model	进水口 Inlet	出水口 Outlet	排水口 Drain	上下布水口 Top and bottom strainer connector	进气口 Gas inlet	排气口 Gas outlet	吸酸碱口 Acid and alkali line connector	产水量 Water capacity m ³ /h	配套混床尺寸 (in) Tank size (inch)
15702	3/4"F	3/4"M	3/4"M	3/4"M	1/2"F	3/4"F	3/8"M	2	10"~12"
15704	1"M	1"M	3/4"M	1"M	1/2"F	3/4"F	3/8"M	4	14"~16"

● F:内牙 M:外牙 OD:外径 1" D-GB:国标公称直径为1寸
 ● F:Female M:Male OD:Outer Diameter 1"D-GB:Chinese nominal diameter is 1"

除氧器用控制阀 Deoxidized Control Valve



4 m³/h

13504(F85)

结构性能特点 Structure Features

- LED显示, 侧面安装, 带信号输出端口、远程控制输入、互锁等功能
 - 多种计时模式可选运行按天计、按小时计、按时间点 (每天可二个、三个或四个时间点)
 - 反洗用水有两种方式可选择; 用除氧水反洗或原水反洗
 - 分左右室, 增大反洗量
- LED display, remote signal input, keyboard lock and other functions.
 - Several time modes optional: Operate by Day, Hour, Point (Two, Three, Four points)
 - It has two type of water for backwash: oxygen removal water or hard water.
 - There are left and right chambers to increase the backwash flow rate.

适用场合 Applications

主要用于蒸汽锅炉供水的除氧, 适用于双室常温海绵铁除氧系统
Steam boiler system and double chambers sponge iron deoxidized system.

型号 Model	进水口 Inlet	出水口 Outlet	排水口 Drain	上下布水口 Top and bottom strainer connector	左右室接口 Left and right chamber connector	产水量 Water capacity m ³ /h	除氧器尺寸 (in) Tank size (in)	备注 Remark
13504 (F85)	1"M	1"M	1"M	1"M	1"M	3.5	10" ~ 16"	除溶解氧 Removal dissolved oxygen

● M--外牙 F--内牙 OD--外径

● Remark: M--Male Thread F--Female Thread OD--Outer Diameter

除氟用控制阀 Fluorine-removal Control Valve



1 m³/h

11501(F83B1)/11601(F83B3)

结构性能特点 Structure Features

- 工艺流程：运行、进再生剂、补水、浸泡、正洗；
- 再生剂泵可由控制板控制；
- LED彩屏显示，停(断)电数据保护；
- 带互锁功能，带信号输出端口和远程控制端口。
- 端面密封启闭方式
- Process Flow: service, reagent entering, refill, soaking, fast Rinse.
- Reagent pump can be controlled by control board.
- LED display, data saved against power supply broke off.
- With interlock function, signal output connector and remote handling connector.
- Hermetic head faces for opening and closing

适用场合 Applications

适用于家用及工业用除氟系统

Residential and industrial fluorine removal system

型号 Model	进水口 Inlet	出水口 Outlet	排水口 Drain	中心管 Riser pipe	进再生剂口 Regenerate reagent inlet	基座 Base	产水量 Water capacity
11501 (F83B1) 11601 (F83B3)	1"M	1"M	1/2"M	1.05"OD	3/8"M	2.5"-8NPSM	1m ³ /h

● M--外牙 F--内牙 OD--外径

● Remark: M--Male Thread F--Female Thread OD--Outer Diameter

其他阀门及配件 Other Accessories

电动三通阀
Electronic
Three-way Valve



42020(F80)



6 m³/h ~ 40 m³/h

叠片式过滤器系列 Disc Filter Series



43024

43029

液位控制器+盐井
Liquid Level Switch & Brine well



3/4" 或 1" 上下布水器
3/4" and 1" top and bottom strainers



1" 直弯活接
1" connector

止回阀
Check Valve



F102/F45/F36/F2



de	9.6	26.7	32	50	90
e	1.5±0.1	2.5±0.15	2.6±0.2	2.7±0.2	2.2±0.15

ABS 管件
ABS pipe



浙江省名牌产品

www.run-xin.com

温州市润新机械制造有限公司
WENZHOU RUNXIN MANUFACTURING MACHINE CO.,LTD

地址：浙江省温州市山福镇润新路169号
No.169, Runxin Road, Shanfu Town, Wenzhou, Zhejiang, China

电话 (Tel) : +86-577-88635628 88630038 邮编 (P.C) : 325021
传真 (Fax) : +86-577-88633258 E-mail:sales@run-xin.com